

TECHNICAL DATA SHEET



ALTERNATOR PRO18L G/4

Three-Phase brushless synchronous alternator with AVR - 4 poles

PRO18L G/4

COMMON DATA

Rated Power at 50Hz	kVA	60	
Rated Power at 60Hz	kVA	72	
Rated Power Factor		0,8	
Nominal Temperature	°C	40	
Control System		self-excited	
Execution		brushless	
Regulation Type		AVR	
Insulation Class		H	
Protection		IP23	
Maximum Over speed	rpm	2250	
Overload		110% of rated power for one hour in a cycle of 6 hours	
Air Flow Requirement	m ³ /min	11,7 at 50Hz	14 at 60Hz
R.F.I. Suppression		Standard EN55011	

REGULATION DATA

AVR	HVR11	HVR30
Sensing	single-phase	three-phase
Voltage Regulation	±1%	±1%
Sustained Short Circuit	> 300% of rated current	

WINDING DATA

Stator Winding	Double layer with auxiliary winding		
Rotor Winding	with damping cage		
Winding Pitch	2/3		
Number of Leads of Stator	12		
Stator Winding Resistance	Ω	0,041 at 20°C	
Rotor Winding Resistance	Ω	5,23 at 20°C	
Exciter Stator Resistance	Ω	13 at 20°C	
Exciter Rotor Resistance	Ω	0,72 at 20°C	
THD at full load	<3%		
THD at no load	<3%		
Excitation at no load	Adc	0,86	
Excitation at full load	Adc	2,4	

STANDARD

References	EN60034-1 ISO8528-3 EN55011
------------	-----------------------------

ON REQUEST

UL 1446, Systems of Insulating Materials - General CSA-C22.2 No. 0, Appendix B, General Requirements - Canadian Electrical Code, Part I

CAN/CSA - C22.2 No. 100-14 (R2009) Motors and Generators, UL1004-1 2nd ed. Rotating Electrical Machines - General Requirements, UL1004-4 2nd ed. Electric Generators

PRO18L G/4

ELECTRICAL DATA

Frequency		50Hz - 1500rpm					60Hz - 1800rpm				
Voltage	V	Double Delta	Series High Wye Parallel Low Wye			Double Delta	Series High Wye Parallel Low Wye				
		115/230	380/220 190/110	400/230 200/115	415/240 208/120	440/254 220/127	138/277	415/240 208/120	440/254 220/127	460/266 230/133	480/277 240/154
Rated Power in Class H (125°C/40°C)	kVA	40	60	60	58	50	48	60	68	72	72
	kW	32	48	48	46,4	40	38,4	48	54,4	57,6	57,6
Rated Power in Class F (105°C/40°C)	kVA	37	55	55	50	45	44,5	50	62	66	66
	kW	29,6	44	44	40	36	35,6	40	49,6	52,8	52,8
Rated Power Standby (150°C/40°C)	kVA	41,5	62	62	60	52	51	62	70	76	76
	kW	33,2	49,6	49,6	48	41,6	40,8	49,6	56	60,8	60,8
Rated Power Standby (163°C/27°C)	kVA	43	65	65	62	55	52,5	64	72	78	78
	kW	34,4	52	52	49,6	44	42	51,2	57,6	62,4	62,4

EFFICIENCY IN CL. H

4/4			89,6%							91,4%
3/4			90,1%							91,8%
2/4			87,5%							89,1%
1/4			82,4%							84,3%

REACTANCES AND TIME CONSTANTS

pcc		0,63								
X _d	- dir. axis synchronous	288%	260%	233%	179%		290%	292%	283%	260%
X' _d	- dir. axis transient	23,3%	21,0%	18,9%	14,5%		23,4%	23,6%	22,9%	21,0%
X'' _d	- dir. axis subtransient	7,8%	7,0%	6,3%	4,8%		7,8%	7,9%	7,6%	7,0%
X _q	- quad. axis reactance	164%	148%	133%	102%		165%	166%	161%	148%
T' _{do}	- O.C. field time constant	195ms								
T' _d	- Transient time constant	15ms								
T'' _d	- Sub-transient time constant	9ms								

MECHANICAL DATA

Bearing non drive end			6307-2RS-C3
Bearing drive end (B3/B14 form)			6309-2RS-C3
Weight of generator	in B2	kg	267,5
	in B3/B14	kg	269,5
	in B3/B9	kg	\

PRO18L G/4

MOMENT OF INERZIA

B3/B9	kg·m ²	\
SAE 7½	kg·m ²	0,511
SAE 8	kg·m ²	0,521
SAE 10	kg·m ²	0,537
SAE 11½	kg·m ²	0,557
SAE 14	kg·m ²	\
SAE 18	kg·m ²	\
B3/B14	kg·m ²	0,523

DERATING CURVES

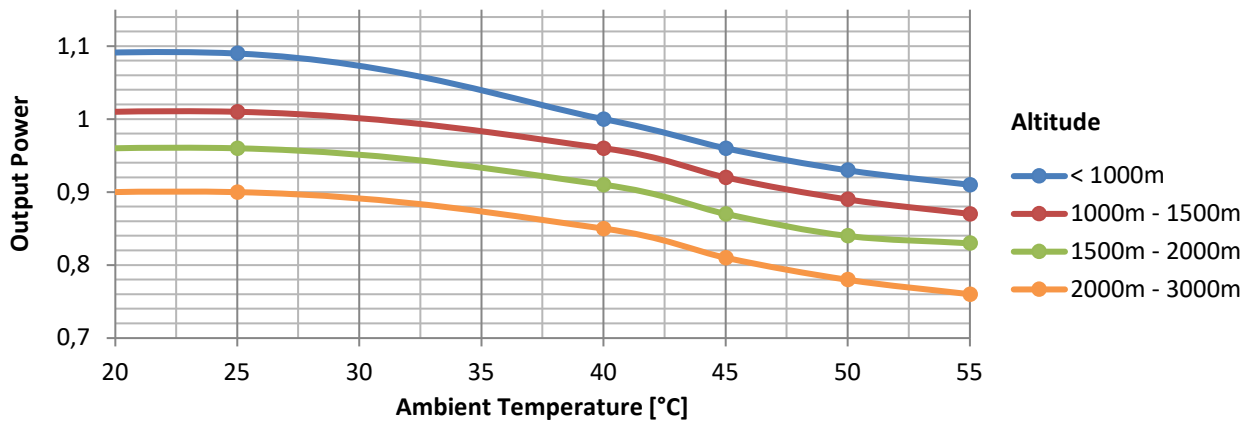

WIRING DIAGRAM

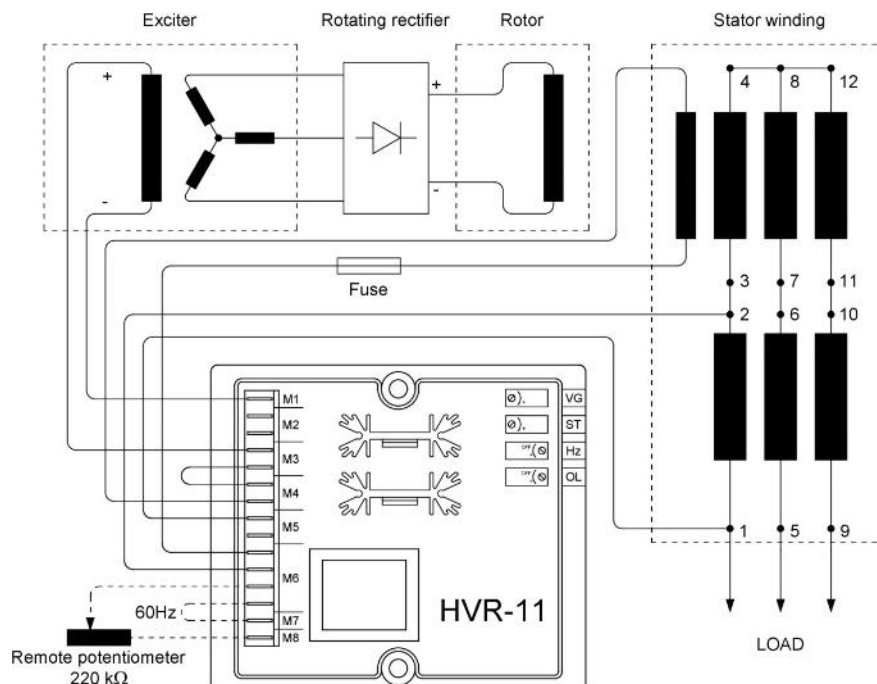

PRO18L G/4

TRANSIENT VOLTAGE VARIATION 50Hz

Transient Voltage Variation @ 50Hz

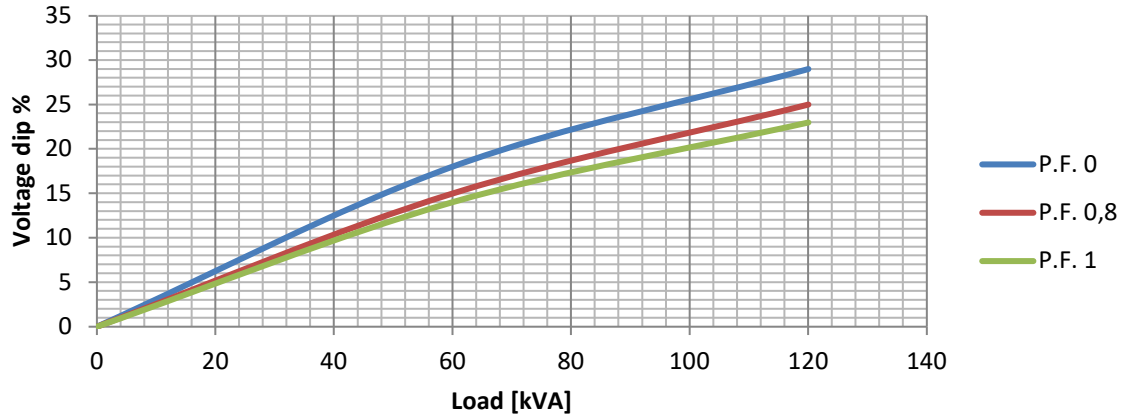

TRANSIENT VOLTAGE VARIATION 60Hz

Transient Voltage Variation @ 60Hz

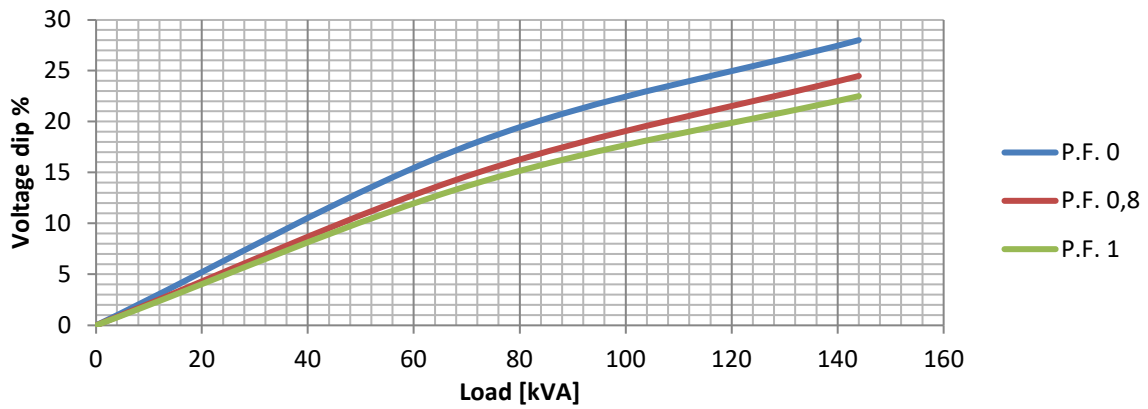

PRO18L G/4

EFFICIENCY 50Hz

Efficiency Curves @ 50Hz

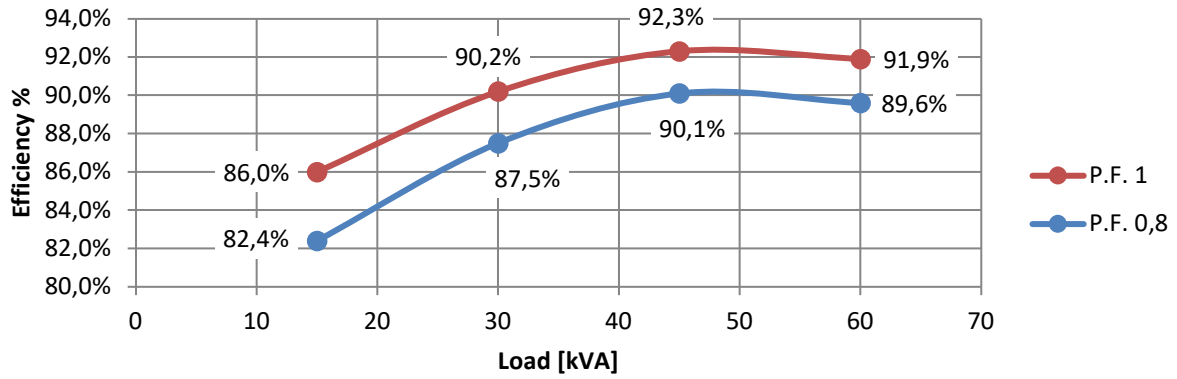

EFFICIENCY 60Hz

Efficiency Curves @ 60Hz

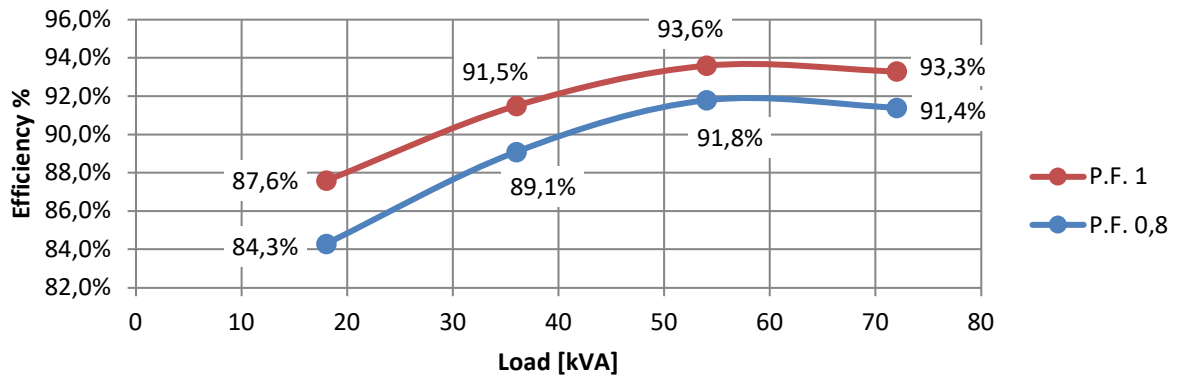

PRO18L G/4

FORMA - FORM B3/B14 'S-M'

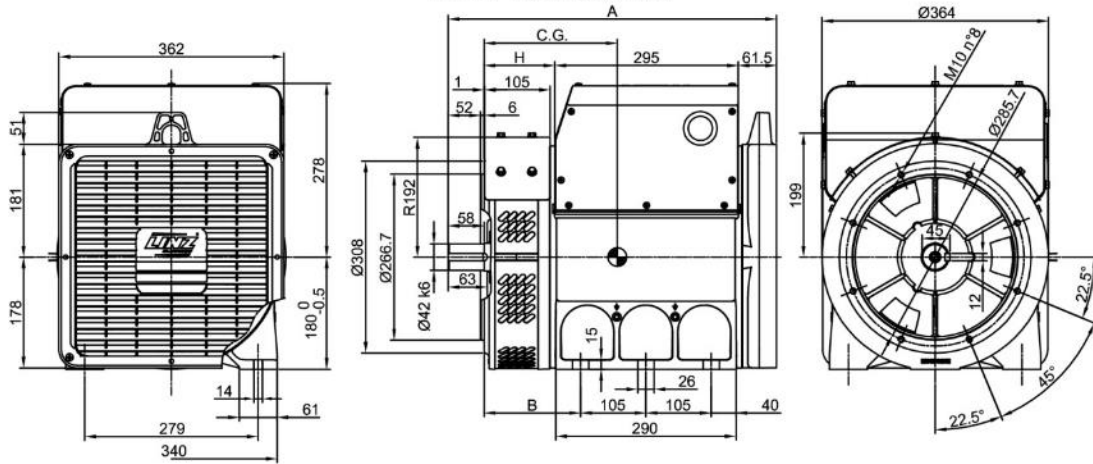

FORMA - FORM B3/B14 'L'

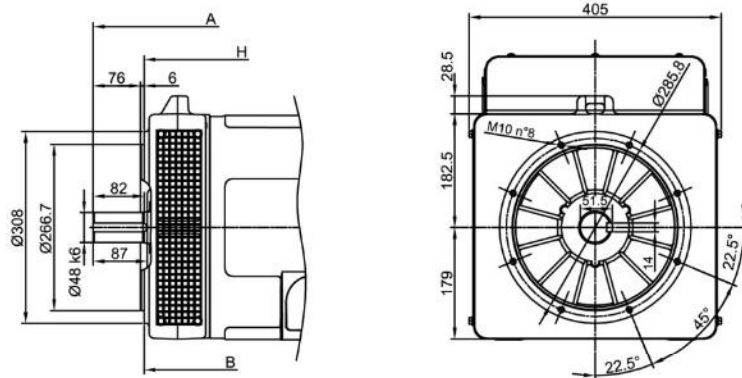

TIPO - TYPE	C.G.
PRO18S A/4 B3/B14	217
PRO18S B/4 B3/B14	221
PRO18S C/4 B3/B14	228
PRO18M D/4 B3/B14	251
PRO18M E/4 B3/B14	262
PRO18L F/4 B3/B14	301
PRO18L G/4 B3/B14	318

TIPO - TYPE	C.G.
PRO18S A/4 SAE	213
PRO18S B/4 SAE	217
PRO18S C/4 SAE	223
PRO18M D/4 SAE	246
PRO18M E/4 SAE	257
PRO18L F/4 SAE	296
PRO18L G/4 SAE	313

FORMA - FORM SAE

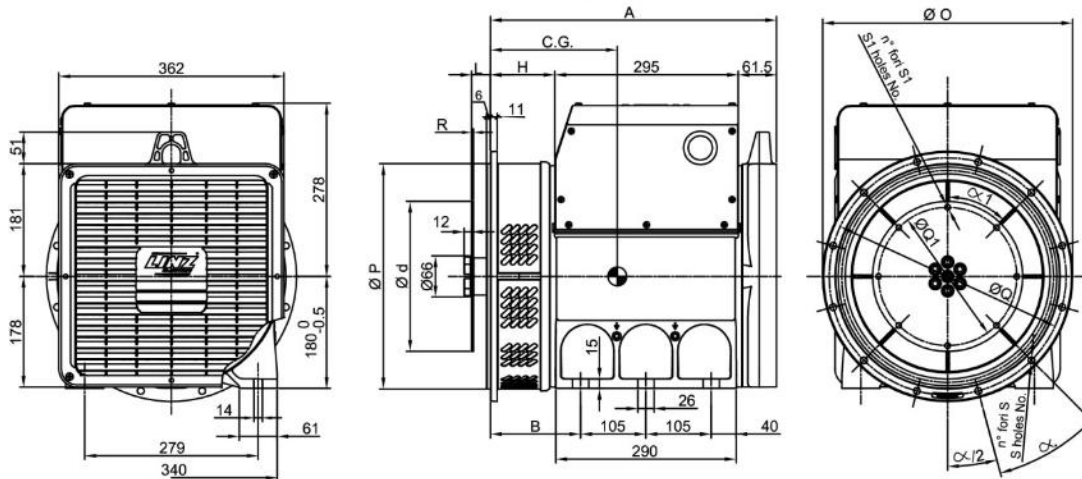

FORMA - FORM	A	B	H
B3/B14	PRO 18S	528	113,5
	PRO 18M	598	183,5
	PRO 18L	734	295,5
SAE	PRO 18S	460	103,5
	PRO 18M	530	173,5
	PRO 18L	642	285,5

SAE N.	FLANGIE - FLANGES - BRIDAS					
	Ø O	Ø P	Ø Q	n. fori holes No.	S	α
5	356	314,3	333,4	8	11	45°
4	402	362	381	12		30°
3	451	409,6	428,6			
2	490	447,7	466,7			

SAE N.	GIUNTI A DISCO - COUPLING DISCS - JUNTAS A DISCOS						
	L	Ø d	Ø Q1	n. fori holes No.	S1	α 1	R
6 1/2	30,2	215,9	200	6	9	60°	3
7 1/2		241,3	222,25	8		45°	
8	62	263,52	244,47	6		60°	
10	53,8	314,32	295,27	8	10,5	45°	4,5
11 1/2	39,6	352,42	333,37				