

TECHNICAL DATA SHEET

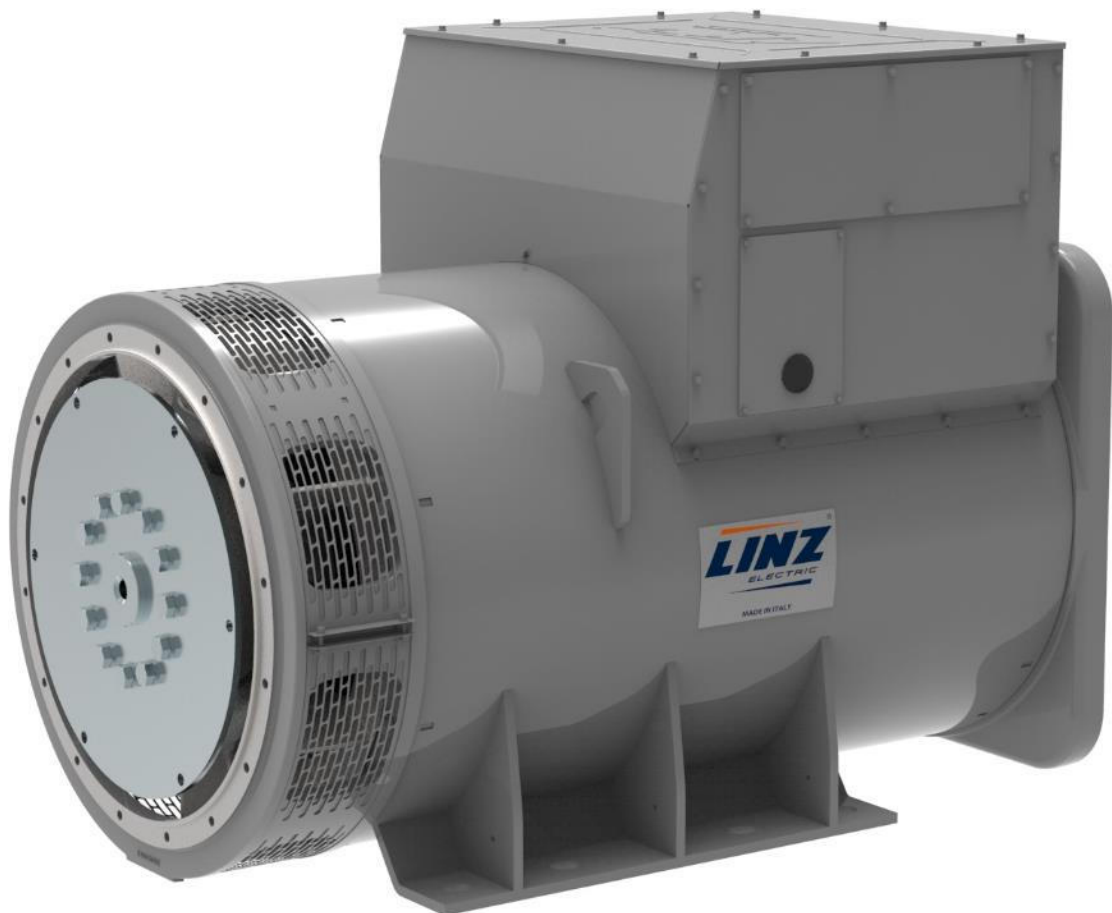

ALTERNATOR PRO40M C/4

Three-Phase brushless synchronous alternator with AVR - 4 poles

PRO40M C/4

COMMON DATA

Rated Power at 50Hz	kVA	1250	
Rated Power at 60Hz	kVA	1500	
Rated Power Factor		0,8	
Nominal Temperature	°C	40	
Control System		self-excited	
Execution		brushless	
Regulation Type		AVR	
Insulation Class		H	
Protection		IP23	
Maximum Over speed	rpm	2250	
Overload		110% of rated power for one hour in a cycle of 6 hours	
Air Flow Requirement	m ³ /min	96 at 50Hz	115 at 60Hz
R.F.I. Suppression		Standard EN55011	

REGULATION DATA

AVR		HVR30
Sensing		three-phase
Voltage Regulation		±1%
Sustained Short Circuit		> 300% of rated current

WINDING DATA

Stator Winding		Double layer with auxiliary winding	
Rotor Winding		with damping cage	
Winding Pitch		2/3	
Number of Leads of Stator		6*	
Stator Winding Resistance	Ω	0,0065 at 20°C	
Rotor Winding Resistance	Ω	0,85 at 20°C	
Exciter Stator Resistance	Ω	13,3 at 20°C	
Exciter Rotor Resistance	Ω	0,051 at 20°C	
THD at full load		< 3%	
THD at no load		< 3%	
Excitation at no load	Adc	0,55	
Excitation at full load	Adc	2,90	

Note (*): 230/400V - 460/800V 50Hz
277/480V - 554/960V 60Hz

STANDARD

References		EN60034-1 ISO8528-3 EN55011
------------	--	-----------------------------

PRO40M C/4

ELECTRICAL DATA

Frequency		50Hz - 1500rpm				60Hz - 1800rpm			
Voltage Series Star	V	380/220	400/230	415/240	440/254	415/240	440/254	460/266	480/277
Rated Power in Class H (125°C/40°C)	kVA	1200	1250	1200	1100	1300	1380	1440	1500
	kW	960	1000	960	880	1040	1104	1152	1200
Rated Power in Class F (105°C/40°C)	kVA	1050	1100	1100	1000	1190	1210	1270	1320
	kW	840	880	880	800	952	968	1016	1056
Rated Power Standby (150°C/40°C)	kVA	1240	1300	1260	1150	1350	1430	1500	1560
	kW	992	1040	1008	920	1080	1144	1200	1248
Rated Power Standby (163°C/27°C)	kVA	1280	1350	1300	1200	1400	1490	1550	1620
	kW	1024	1080	1040	960	1120	1192	1240	1296

EFFICIENCY IN CL. H @ 0.8P.F

4/4	95,7%							96,3%
3/4	96,0%							96,4%
2/4	94,8%							95,2%
1/4	91,8%							93,0%

REACTANCES AND TIME CONSTANTS

pcc		0,35							
X _d - dir. axis synchronous		238%	224%	200%	163%	253%	245%	234%	224%
X' _d - dir. axis transient		36,2%	34,0%	30,3%	24,7%	39,4%	37,2%	35,5%	34,0%
X'' _d - dir. axis subtransient		15,5%	14,6%	13,0%	10,6%	16,9%	16,0%	15,3%	14,6%
X _q - quad. axis reactance		127%	119%	106%	87%	138%	130%	125%	119%
T' _{do} - O.C. field time constant		1751ms							
T' _d - Transient time constant		194ms							
T'' _d - Sub-transient time constant		20ms							

MECHANICAL DATA

Bearing non drive end	6318-2RS1-C3		
Bearing drive end (B3/B14 form)	6324-C3		
Weight of generator in B2	kg	2276	
in B3/B14	kg	2331	

PRO40M C/4

MOMENT OF INERZIA

SAE 14	kg·m ²	20,414
SAE 18	kg·m ²	20,807
SAE 21	kg·m ²	21,457
B3/B14	kg·m ²	19,207

DERATING CURVES

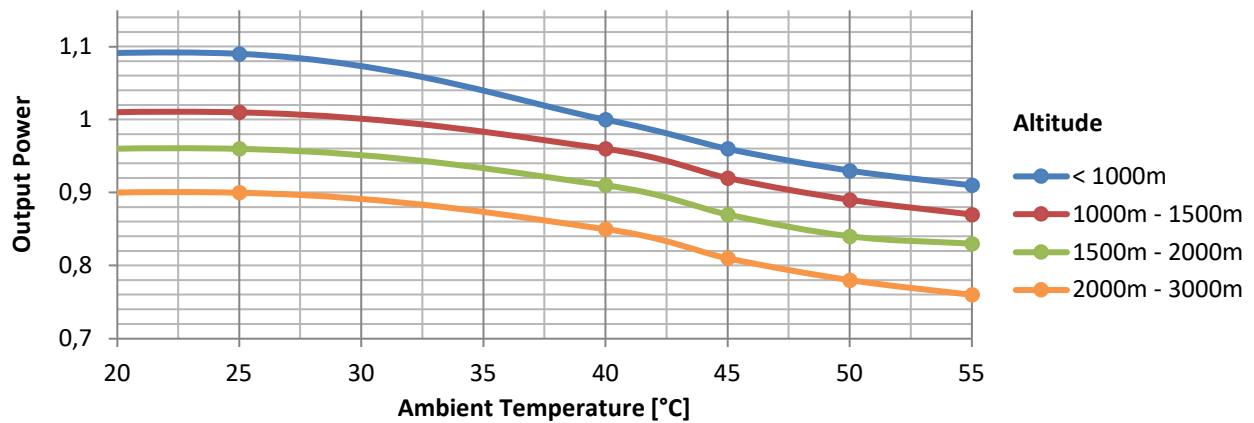

WIRING DIAGRAM

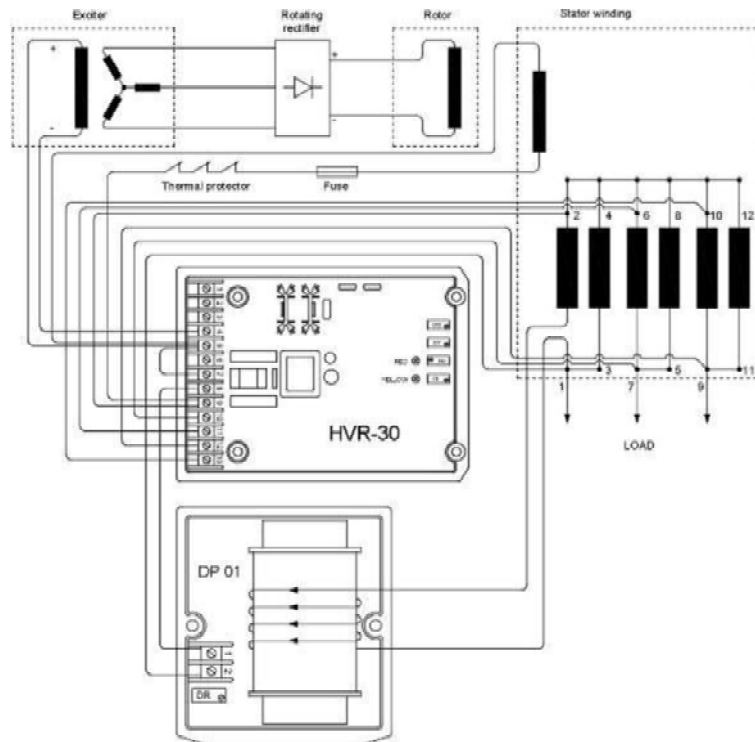

PRO40M C/4

TRANSIENT VOLTAGE VARIATION 50Hz

Transient Voltage Variation @ 50Hz

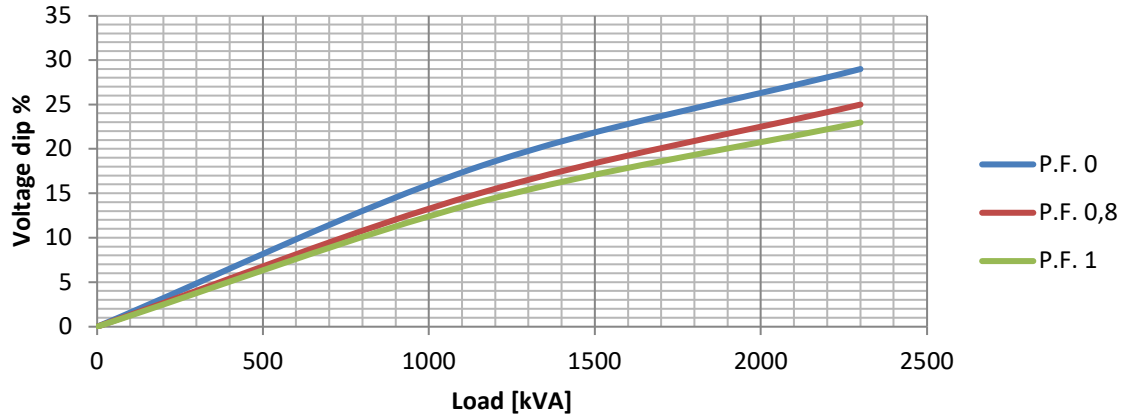

TRANSIENT VOLTAGE VARIATION 60Hz

Transient Voltage Variation @ 60Hz

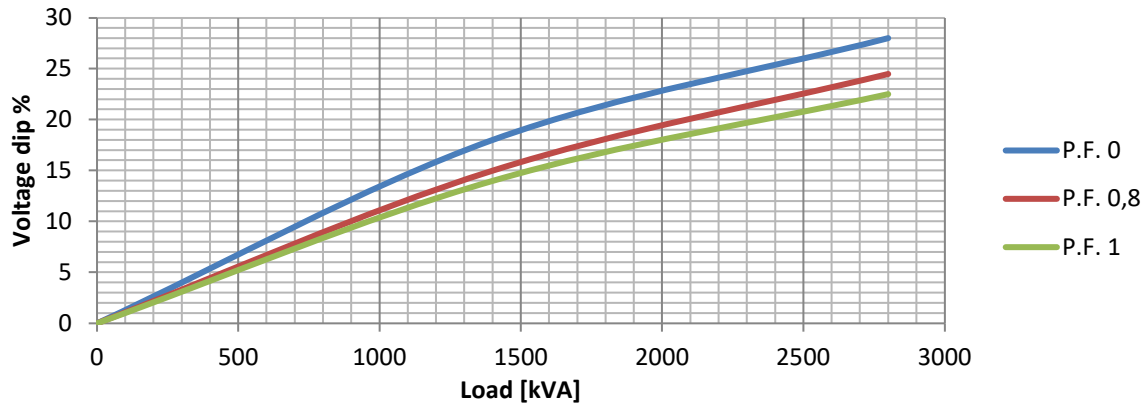

PRO40M C/4

EFFICIENCY 50Hz

Efficiency Curves @ 50Hz

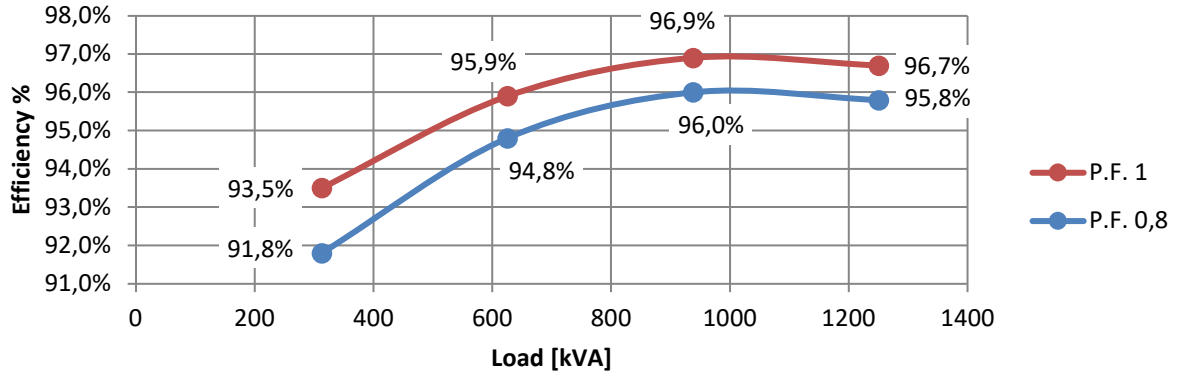

EFFICIENCY 60Hz

Efficiency Curves @ 60Hz

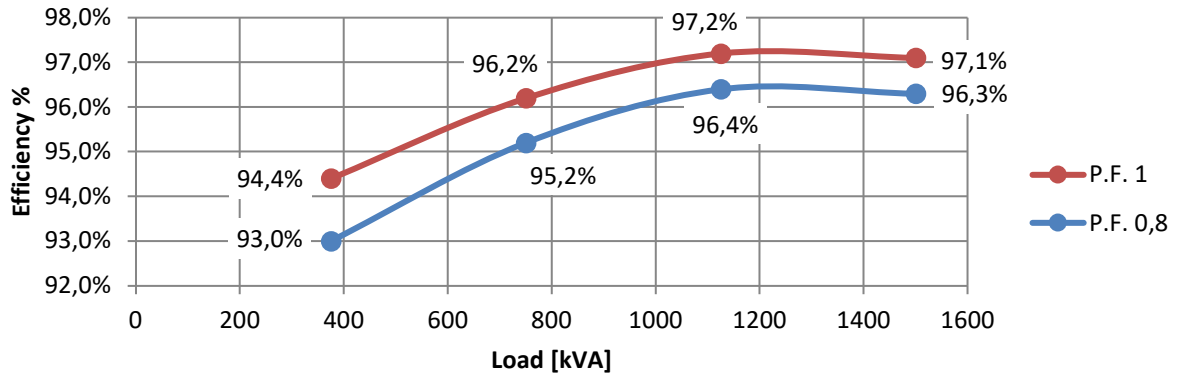

PRO40M C/4

FORMA - FORM B3/B14

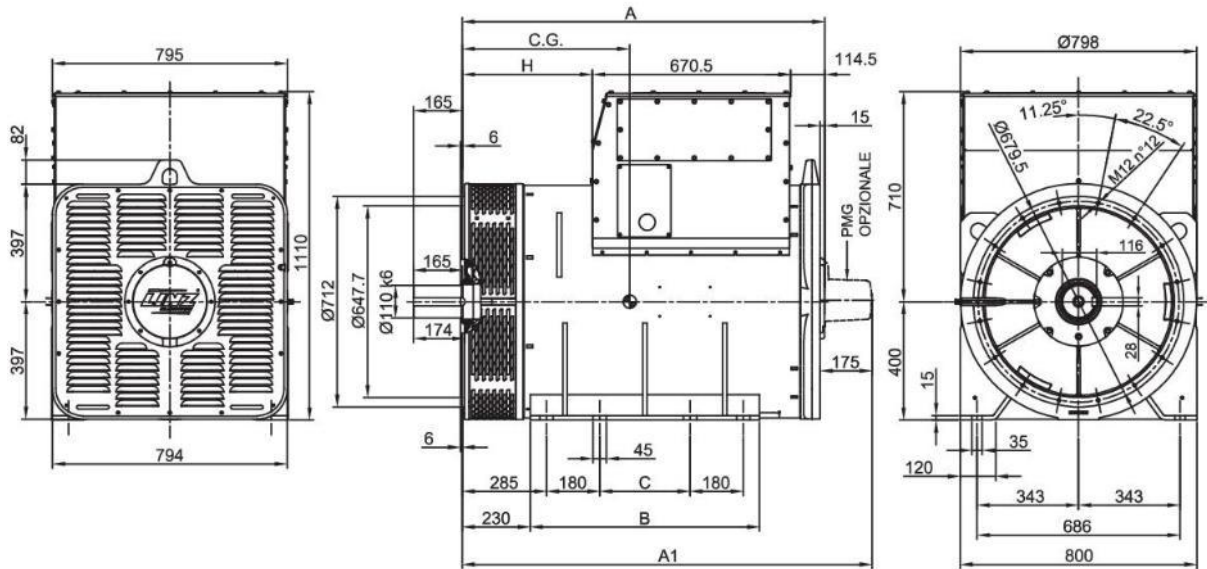

FORMA - FORM SAE

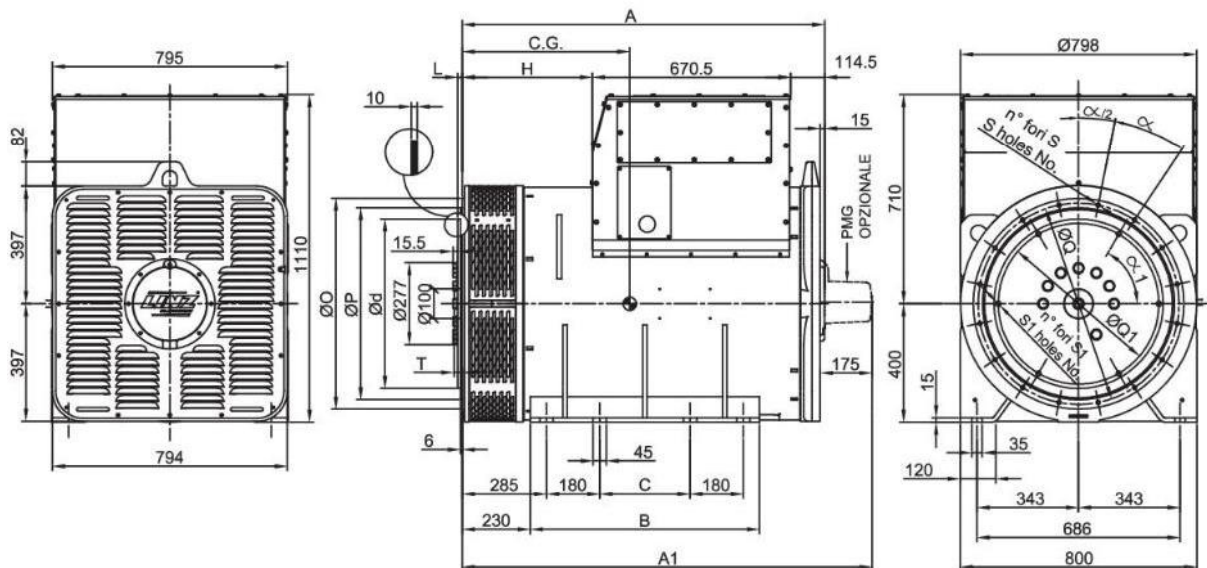

FORMA - FORM	A	H	A1	B	C	
B3/B14	PRO40 S	1225	440	1385	775	305
	PRO40 M	1420	635	1580	775	305
	PRO40 L	1625	840	1785	965	495
SAE	PRO40 S	1225	440	1385	775	305
	PRO40 M	1420	635	1580	775	305
	PRO40 L	1625	840	1785	965	495

TIPO - TYPE	C.G.
PRO40S A/4	597
PRO40S B/4	597
PRO40M C/4	648
PRO40M D/4	693
PRO40L E/4	795

SAE N.	FLANGIE - FLANGES - BRIDAS					
	Ø O	Ø P	Ø Q	n. fori holes No.	S	α
OO	883	787.4	850.9	16	14	22.5°
O	710	647.7	679.5	16	14	22.5°

SAE N.	GIUNTI A DISCO - COUPLING DISCS - JUNTAS A DISCOS						
	L	Ø d	Ø Q1	n. fori holes No.	S1	α/1	T
14	25.4	466.72	438.15	8	14	45°	2
18	15.7	571.5	542.92	6	17	60°	12
21	0	673.1	641.35	12	17	30°	28