

XN7G - Technical Data Sheet

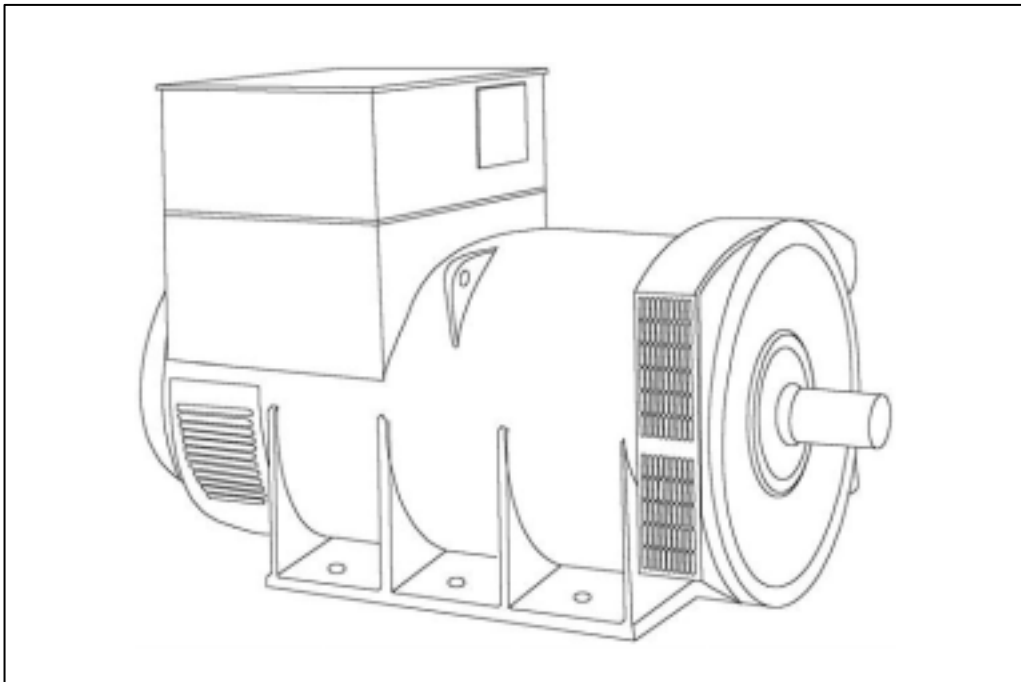

XN7G

SPECIFICATIONS & OPTIONS

STANDARDS

Xingnuo industrial generators meet the requirements of BS EN 60034 and the relevant section of other international standards such as BS5000, VDE 0530, NEMA MG1-32, IEC34, CSA C22.2-100, AS1359. Other standards and certifications can be considered on request.

VOLTAGE REGULATORS

MX321 AVR - STANDARD

This sophisticated Automatic Voltage Regulator (AVR) is incorporated into the Stamford Permanent Magnet Generator (PMG) system and is fitted as standard to generators of this type.

The PMG provides power via the AVR to the main exciter, giving a source of constant excitation power independent of generator output. The main exciter output is then fed to the main rotor, through a full wave bridge, protected by a surge suppressor. The AVR has in-built protection against sustained over-excitation, caused by internal or external faults. This de-excites the machine after a minimum of 5 seconds.

Over voltage protection is built-in and short circuit current level adjustments is an optional facility.

WINDINGS & ELECTRICAL PERFORMANCE

All generator stators are wound to 2/3 pitch. This eliminates triplen (3rd, 9th, 15th ...) harmonics on the voltage waveform and is found to be the optimum design for trouble-free supply of non-linear loads. The 2/3 pitch design avoids excessive neutral currents sometimes seen with higher winding pitches, when in parallel with the mains. A fully connected damper winding reduces oscillations during paralleling. This winding, with the 2/3 pitch and carefully selected pole and tooth designs, ensures very low waveform distortion.

TERMINALS & TERMINAL BOX

Standard generators feature a main stator with 6 ends brought out to the terminals, which are mounted on the frame at the non-drive end of the generator. A sheet steel terminal box contains the AVR and provides ample space for the customers' wiring and gland arrangements. It has removable panels for easy access.

SHAFT & KEYS

All generator rotors are dynamically balanced to better than BS6861:Part 1 Grade 2.5 for minimum vibration in operation. Two bearing generators are balanced with a half key.

INSULATION/IMPREGNATION

The insulation system is class 'H'. All wound components are impregnated with materials and processes designed specifically to provide the high build required for static windings and the high mechanical strength required for rotating components.

QUALITY ASSURANCE

Generators are manufactured using production procedures having a quality assurance level to BS EN ISO 9001.

The stated voltage regulation may not be maintained in the presence of certain radio transmitted signals. Any change in performance will fall within the limits of Criteria 'B' of EN 61000-6-2:2001. At no time will the steady-state voltage regulation exceed 2%.

NB Continuous development of our products entitles us to change specification details without notice, therefore they must not be regarded as binding.

Front cover drawing typical of product range.

XN7G

WINDING 312

| | | | |
|-------------------------|--|--------------------------|--|
| CONTROL SYSTEM | SEPARATELY EXCITED BY P.M.G. | | |
| A.V.R. | MX321 | | |
| VOLTAGE REGULATION | ± 0.5 % | With 4% ENGINE GOVERNING | |
| SUSTAINED SHORT CIRCUIT | REFER TO SHORT CIRCUIT DECREMENT CURVES (page 7) | | |

| | | | |
|------------------------|--|--|--|
| INSULATION SYSTEM | CLASS H | | |
| PROTECTION | IP21 | | |
| RATED POWER FACTOR | 0.8 | | |
| STATOR WINDING | DOUBLE LAYER LAP | | |
| WINDING PITCH | TWO THIRDS | | |
| WINDING LEADS | 6 | | |
| STATOR WDG. RESISTANCE | 0.00093 Ohms PER PHASE AT 22°C STAR CONNECTED | | |
| ROTOR WDG. RESISTANCE | 1.65 Ohms at 22°C | | |
| R.F.I. SUPPRESSION | BS EN 61000-6-2 & BS EN 61000-6-4, VDE 0875G, VDE 0875N. refer to factory for others | | |
| WAVEFORM DISTORTION | NO LOAD < 1.5% NON-DISTORTING BALANCED LINEAR LOAD < 5.0% | | |
| MAXIMUM OVERSPEED | 2250 Rev/Min | | |
| BEARING DRIVE END | BALL. 6228 (ISO) | | |
| BEARING NON-DRIVE END | BALL. 6319 (ISO) | | |

| | 1 BEARING | | | | 2 BEARING | | | |
|--|-----------------------------------|---------|---------|---------|-----------------------------------|---------|---------|---------|
| WEIGHT COMP. GENERATOR | 3541 kg | | | | 3635 kg | | | |
| WEIGHT WOUND STATOR | 1852 kg | | | | 1852 kg | | | |
| WEIGHT WOUND ROTOR | 1494 kg | | | | 1431 kg | | | |
| WR ² INERTIA | 45.5872 kgm ² | | | | 44.5864 kgm ² | | | |
| SHIPPING WEIGHTS in a crate | 3614kg | | | | 3704kg | | | |
| PACKING CRATE SIZE | 216 x 105 x 154 (cm) | | | | 216 x 105 x 154 (cm) | | | |
| | 50 Hz | | | | 60 Hz | | | |
| TELEPHONE INTERFERENCE | THF<2% | | | | TIF<50 | | | |
| COOLING AIR | 2.64 m ³ /sec 5600 cfm | | | | 3.17 m ³ /sec 6720 cfm | | | |
| VOLTAGE STAR | 380/220 | 400/231 | 415/240 | 440/254 | 416/240 | 440/254 | 460/266 | 480/277 |
| KVA BASE RATING FOR REACTANCE VALUES | 1800 | 1800 | 1800 | 1800 | 2063 | 2163 | 2213 | 2281 |
| X _d DIR. AXIS SYNCHRONOUS | 2.84 | 2.56 | 2.38 | 2.12 | 3.29 | 3.08 | 2.88 | 2.73 |
| X' _d DIR. AXIS TRANSIENT | 0.23 | 0.21 | 0.20 | 0.17 | 0.25 | 0.24 | 0.22 | 0.21 |
| X'' _d DIR. AXIS SUBTRANSIENT | 0.17 | 0.15 | 0.14 | 0.12 | 0.19 | 0.18 | 0.17 | 0.16 |
| X _q QUAD. AXIS REACTANCE | 2.11 | 1.90 | 1.77 | 1.57 | 2.43 | 2.28 | 2.13 | 2.02 |
| X'' _q QUAD. AXIS SUBTRANSIENT | 0.31 | 0.28 | 0.26 | 0.23 | 0.35 | 0.33 | 0.31 | 0.29 |
| X _L LEAKAGE REACTANCE | 0.08 | 0.07 | 0.07 | 0.06 | 0.08 | 0.08 | 0.07 | 0.07 |
| X ₂ NEGATIVE SEQUENCE | 0.27 | 0.24 | 0.22 | 0.20 | 0.29 | 0.27 | 0.25 | 0.24 |
| X ₀ ZERO SEQUENCE | 0.03 | 0.03 | 0.03 | 0.02 | 0.04 | 0.03 | 0.03 | 0.03 |

REACTANCES ARE SATURATED

VALUES ARE PER UNIT AT RATING AND VOLTAGE INDICATED

| | |
|---|------------------|
| T' _d TRANSIENT TIME CONST. | 0.33s |
| T'' _d SUB-TRANSTIME CONST. | 0.03s |
| T' _{do} O.C. FIELD TIME CONST. | 3.41s |
| T _a ARMATURE TIME CONST. | 0.08s |
| SHORT CIRCUIT RATIO | 1/X _d |

**50
Hz**

**XN7G
Winding 312**

THREE PHASE EFFICIENCY CURVES

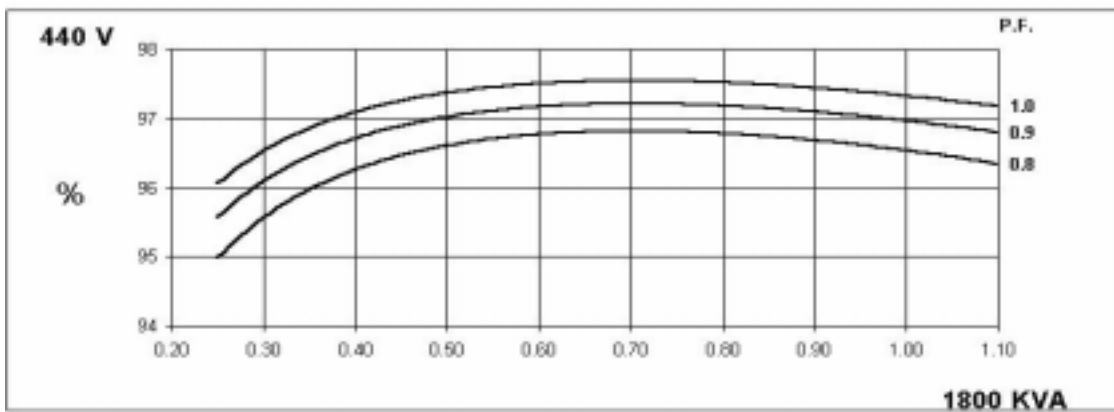
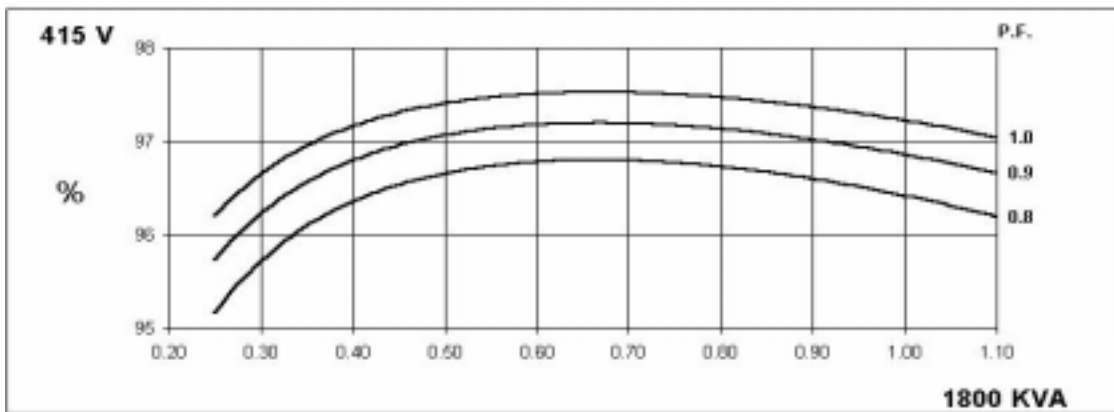
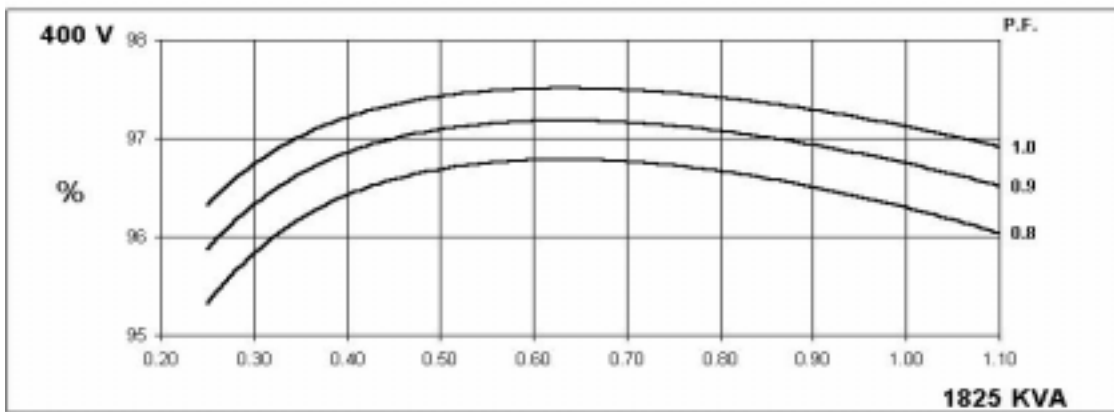
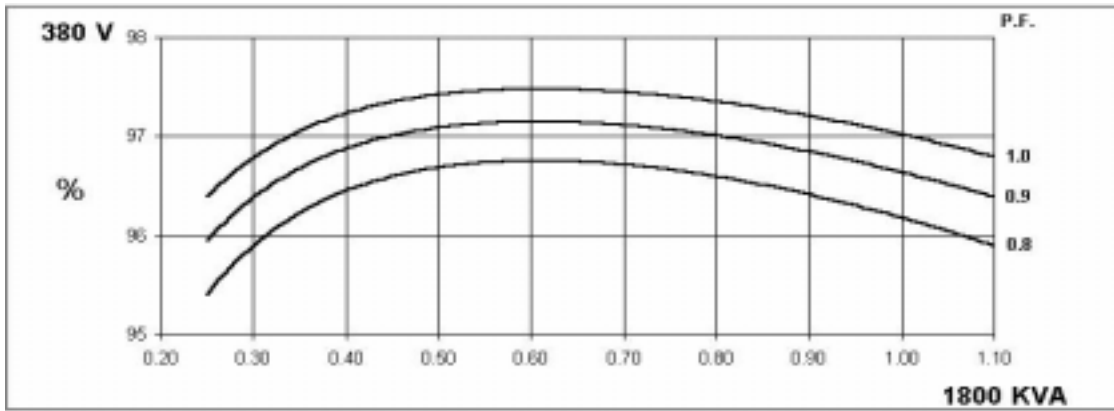

XN7G
Winding 312

60
Hz

THREE PHASE EFFICIENCY CURVES

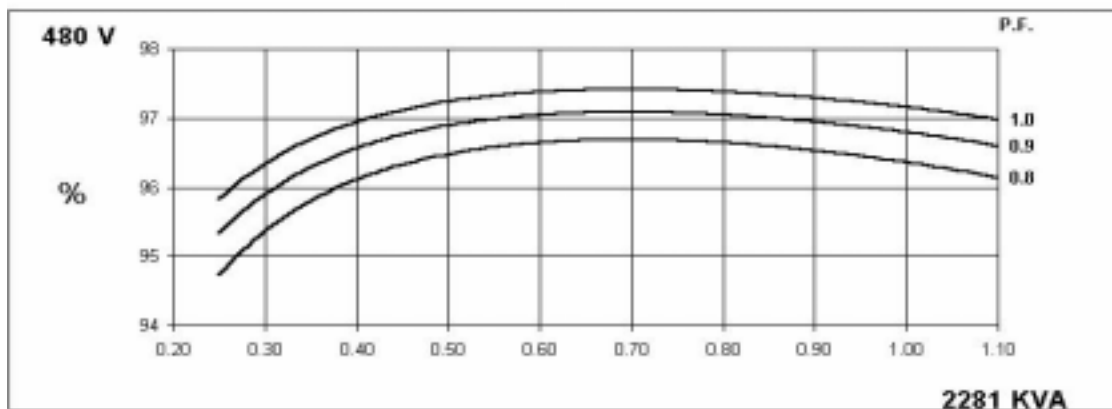
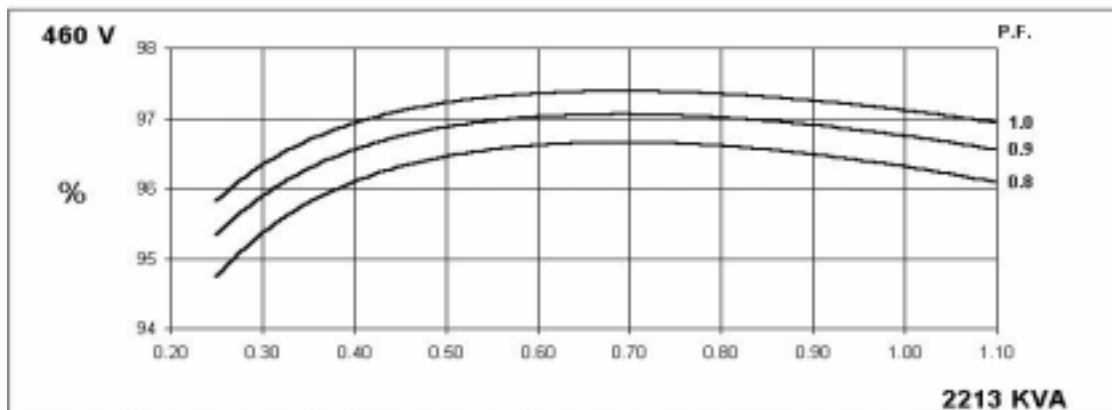
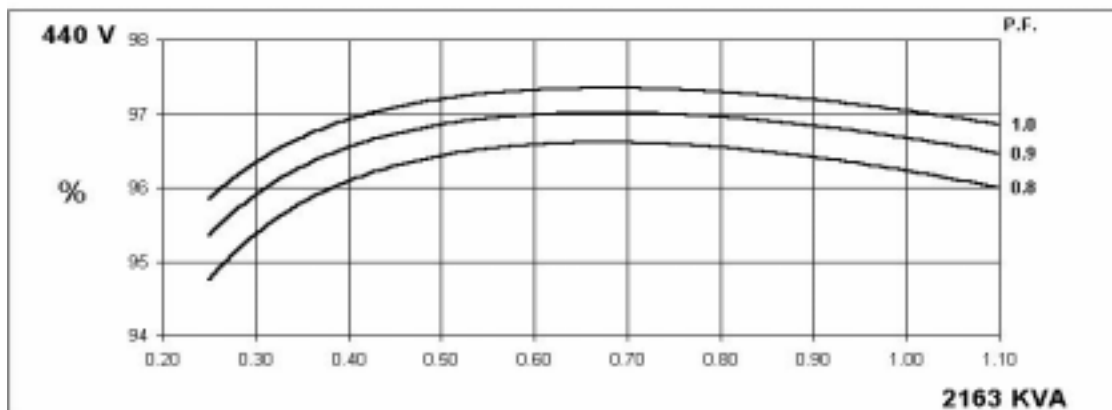
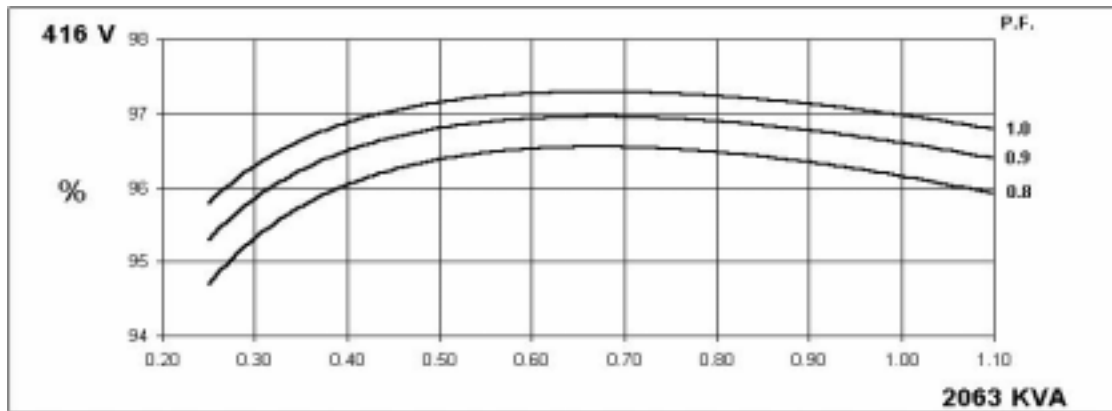

XN7G
Winding 312

Locked Rotor Motor Starting Curve

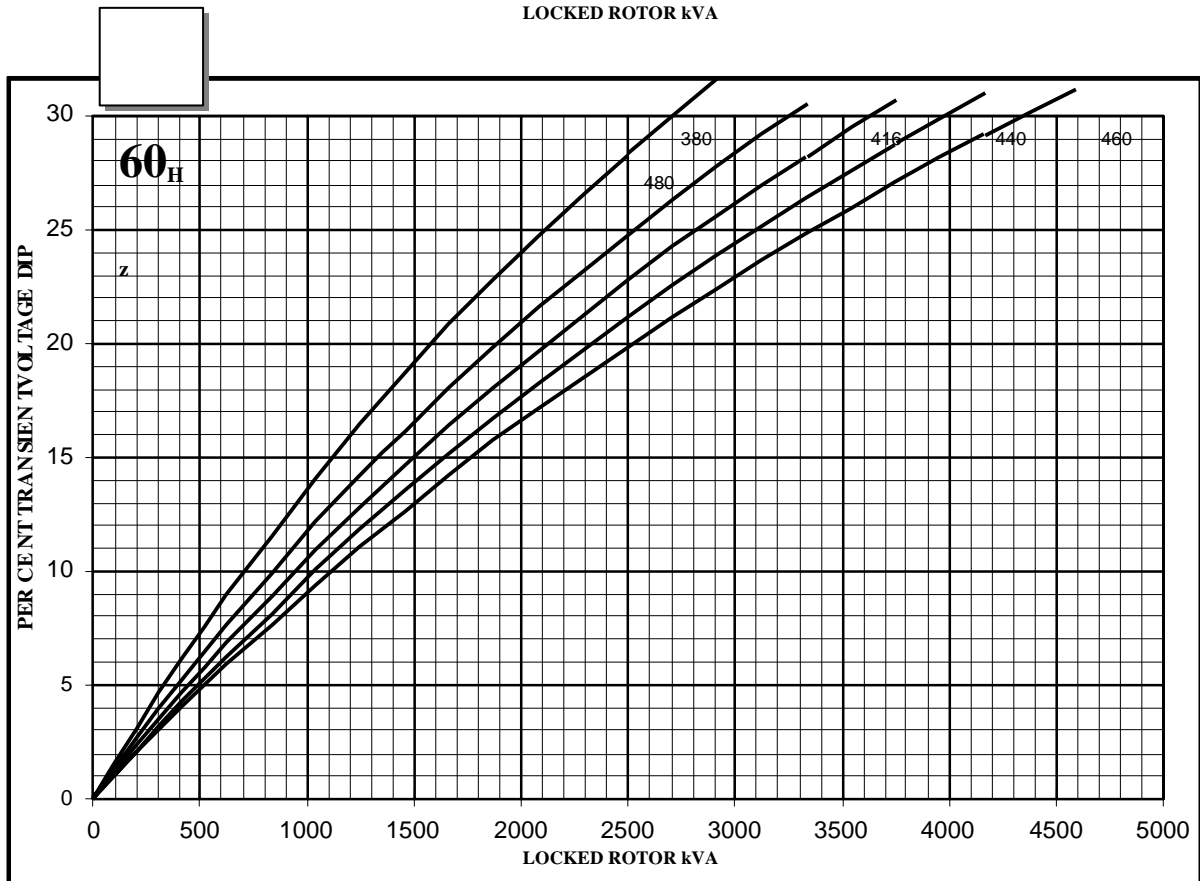
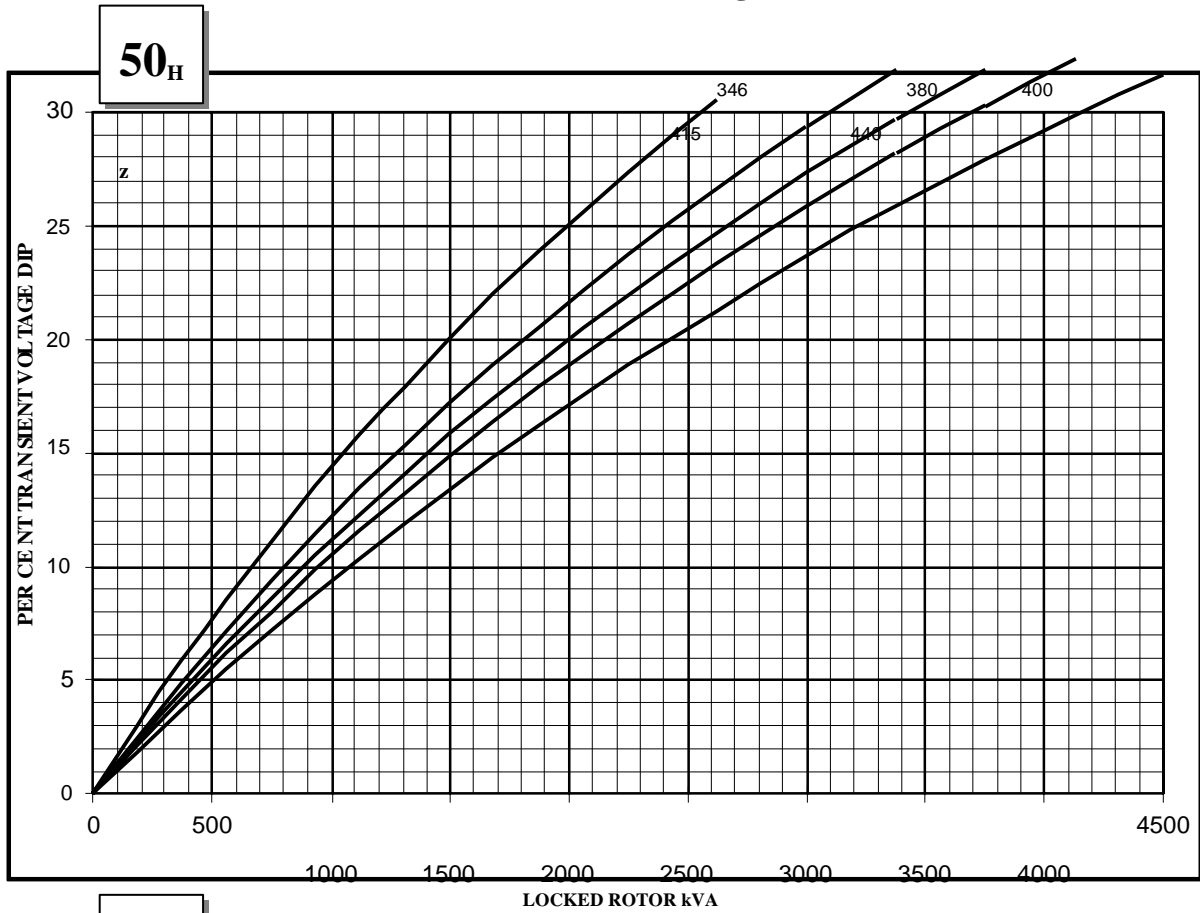

XN7G

Three-phase Short Circuit Decrement Curve. No-load Excitation at Rated Speed Based on Star (wye) connection.

**50
Hz**

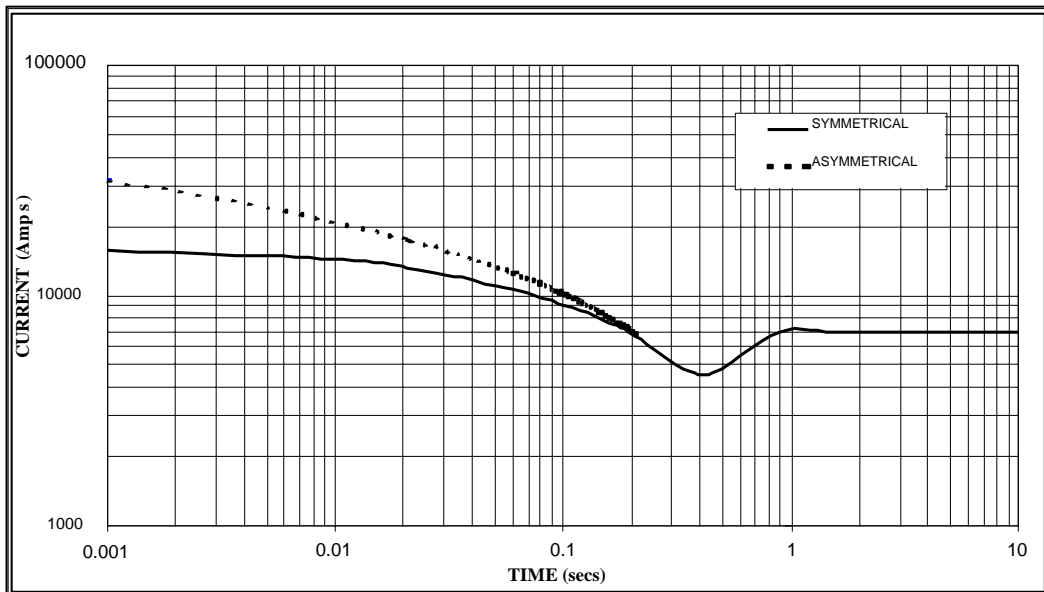

Sustained Short Circuit = 7,000 Amps

**60
Hz**

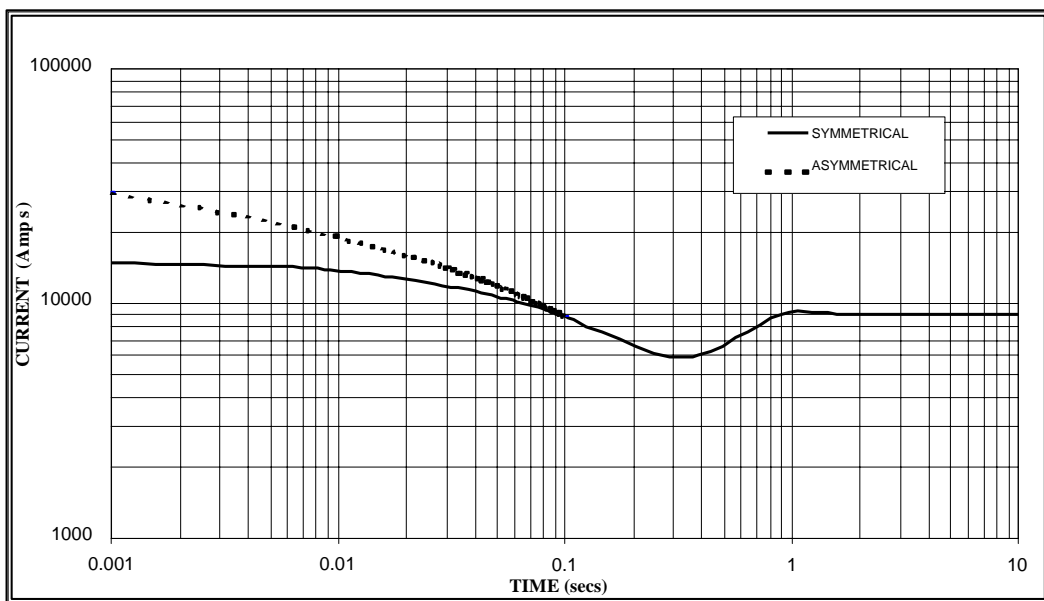

Sustained Short Circuit = 9,000 Amps

Note 1

The following multiplication factors should be used to adjust the values from curve between time 0.001 seconds and the minimum current point in respect of nominal operating voltage :

| 50HZ | | 60HZ | |
|---------|--------|---------|--------|
| Voltage | Factor | Voltage | Factor |
| 380v | x 1.00 | 416v | x 1.00 |
| 400v | x 1.05 | 440v | x 1.06 |
| 415v | x 1.09 | 460v | x 1.10 |
| 440v | x 1.16 | 480v | x 1.15 |

The sustained current value is constant irrespective of voltage level

Note 2

The following multiplication factor should be used to convert the values calculated in accordance with NOTE 1 to those applicable to the various types of short circuit :

| | 3-phase | 2-phase L-L | 1-phase L-N |
|-------------------------|---------|-------------|-------------|
| Instantaneous | x 1.00 | x 0.87 | x 1.30 |
| Minimum | x 1.00 | x 1.80 | x 3.20 |
| Sustained | x 1.00 | x 1.50 | x 2.50 |
| Max. sustained duration | 10 sec. | 5 sec. | 2 sec. |

All other times are unchanged

Note 3

Curves are drawn for Star (Wye) connected machines.

XN7G

Winding 312 / 0.8 Power Factor

RATINGS

| Class - Temp Rise | | Cont. F - 105/40°C | | | | Cont. H - 125/40°C | | | | Standby - 150/40°C | | | | Standby - 163/27°C | | | |
|-------------------|----------------|--------------------|------|------|------|--------------------|------|------|------|--------------------|------|------|------|--------------------|------|------|------|
| 50 | Star (V) | 380 | 400 | 415 | 440 | 380 | 400 | 415 | 440 | 380 | 400 | 415 | 440 | 380 | 400 | 415 | 440 |
| | Hz | | | | | | | | | | | | | | | | |
| | kVA | 1675 | 1700 | 1675 | 1675 | 1800 | 1825 | 1800 | 1800 | 1860 | 1885 | 1860 | 1860 | 1930 | 1955 | 1930 | 1930 |
| | kW | 340 | 360 | 340 | 340 | 440 | 460 | 440 | 440 | 1488 | 1508 | 1488 | 1488 | 1544 | 1564 | 1544 | 1544 |
| | Efficiency (%) | 96.3 | 96.4 | 96.6 | 96.6 | 96.2 | 96.3 | 96.4 | 96.5 | 96.1 | 96.2 | 96.4 | 96.5 | 96.0 | 96.1 | 96.3 | 96.4 |
| | kW Input | 1391 | 1411 | 1387 | 1387 | 1497 | 1516 | 1494 | 1492 | 1548 | 1568 | 1544 | 1542 | 1608 | 1627 | 1603 | 1602 |

| Star (V) | | 416 | 440 | 460 | 480 | 416 | 440 | 460 | 480 | 416 | 440 | 460 | 480 | 416 | 440 | 460 | 480 |
|-----------|----------------|------|------|------|------|------|------|------|------|------|------|------|------|------|------|------|------|
| 60 | kVA | 1900 | 1988 | 2038 | 2100 | 2063 | 2163 | 2213 | 2281 | 2175 | 2281 | 2338 | 2413 | 2250 | 2344 | 2413 | 2500 |
| | kW | 1520 | 1590 | 1630 | 1680 | 1650 | 1730 | 1770 | 1825 | 1740 | 1825 | 1870 | 1930 | 1800 | 1875 | 1930 | 2000 |
| Hz | Efficiency (%) | 96.3 | 96.4 | 96.5 | 96.5 | 96.2 | 96.2 | 96.3 | 96.4 | 96.0 | 96.1 | 96.2 | 96.2 | 95.9 | 96.0 | 96.1 | 96.2 |
| | kW Input | 1578 | 1650 | 1690 | 1741 | 1716 | 1799 | 1838 | 1893 | 1813 | 1899 | 1944 | 2007 | 1877 | 1953 | 2009 | 2079 |

DIMENSIONS

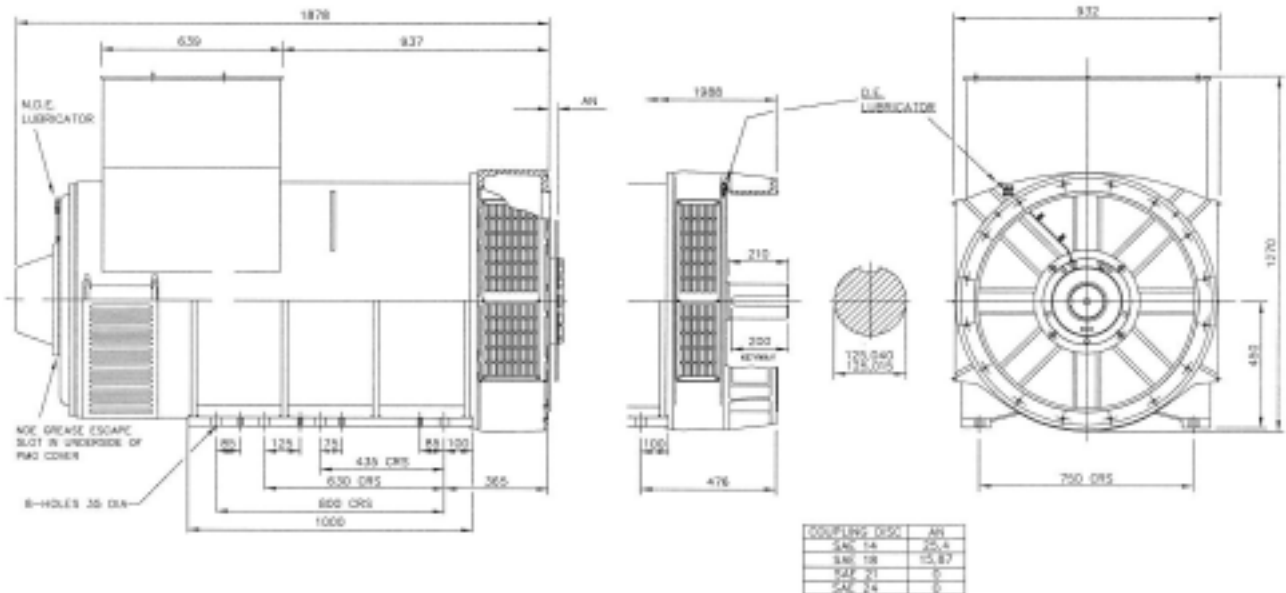

Add: LuoShe Town, Wuxi, P.R. China
 Tel: 0510-83311285 83315170 • Fax: 0510-83303017
[Http://www.wxingnuo.cn/](http://www.wxingnuo.cn/)