

## XN4FG DATA SHEET

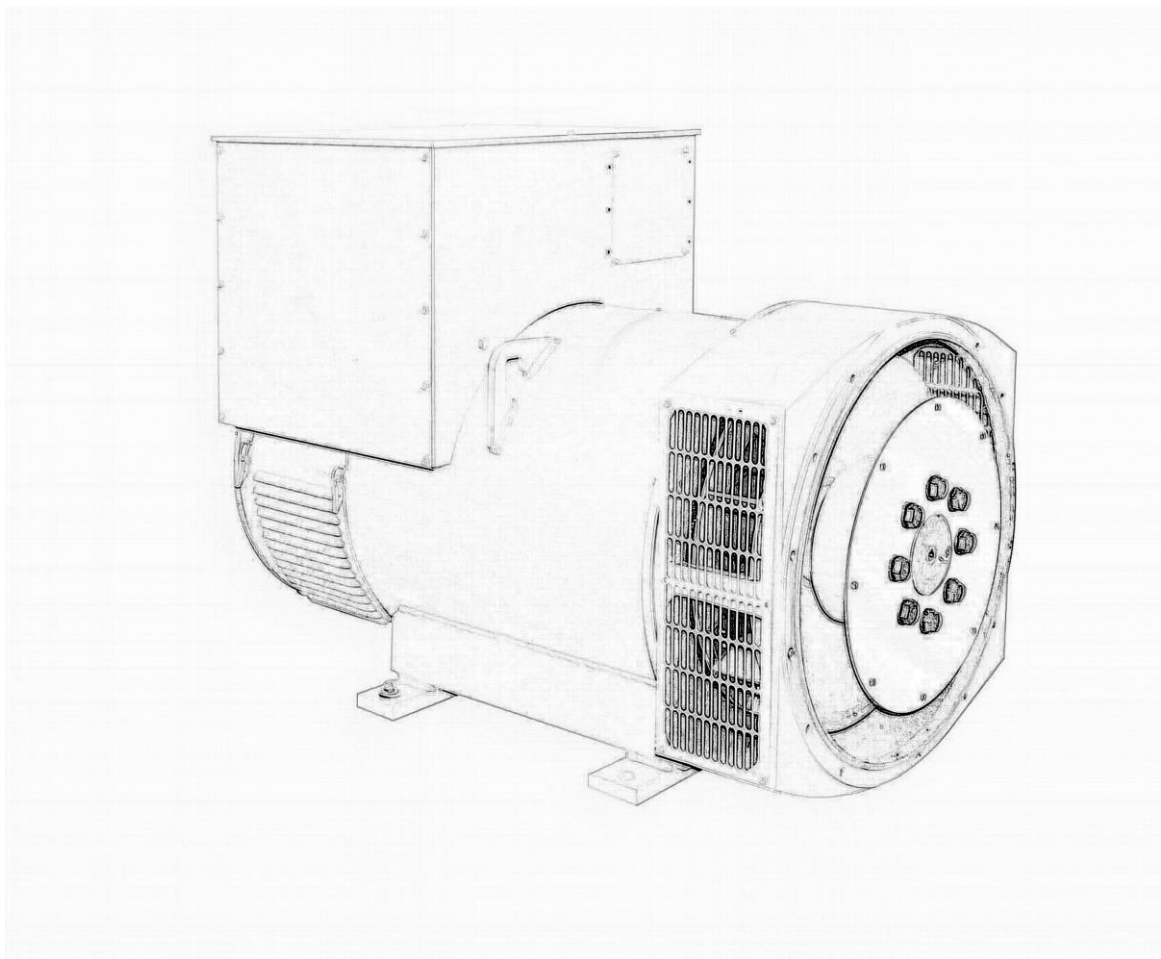

# SPECIFICATIONS & OPTIONS

## Standards

- XN series alternator conforms to the major international standards and specifications, including:
  - IEC60034, GB755, BS5000, VDE0530, NEMA, MG1-22, C22.2-100, CSA, AS1359 standard, etc.
- XN series alternator is certified by ISO9001 quality system.
- XN series alternator can be used for the generator set of CE mark.
- Other standards and certification can be based on customer requirements.

## Electrical characteristics

- Insulation & Impregnating
  - Class H insulation.
  - All wound components are impregnated with material and processes designed specially to provide protection against harsh environments encountered in generator application. Resin based materials are selected and developed to provide the high build required for static windings and the high mechanical strength required for rotating components.
- 3-phase reconnectable with 12 ends brought out to the terminals.
- 2/3 pitch , can eliminates triple (3rd, 9th, 15th ...) harmonics on the voltage waveform and is found to be the optimum design for trouble-free supply of non-linear loads.
- Telephone interference
  - THF(as defined by IEC 60034-1) is less than 2%, TIF(as defined by NEMA MG1-32) is less than 50.
- Radio interference
  - Brushless device and the high quality AVR ensure low levels of interference with radio transmissions. RFI suppression module may be installed if required.
- High efficiency and motor startup capability.

## Mechanical properties

- Steel structure.
- Cast aluminum for front and rear cover.
- Rigid assembly, effectively reduces the vibration during running.
- All rotors are dynamically balanced to conform with BS6861.
- Half key dynamic balance is applied in double bearing structure.
- Non-maintenance sealed-for-life ball bearing.
- 120% overspeed ability.
- Standard
  - Protection grade
  - XN series alternator protection level is IP23.
  - Suitable for environment with 95% relative humidity.
  - optional
    - Inlet and filter, power reduced by 5%.
    - Inlet and outlet filter, power reduced by 10% (IP44)
    - Anti-condensation heater.
    - Stator winding, bearing overheating protection.
    - Outlet line design of outlet box.
    - Center height can be customized according to requirements.

## Excitation and voltage regulation system

MODEL	16 series	18 series	22 series	27 series	4 series	5 series	6 series	7 series
AVR								
SX460	Standard	Standard	Standard	Standard				
AS440( parallel optional)	Optional	Optional	Optional	Optional				
SX440( parallel optional)			Optional	Optional	Standard	Standard		
MX341(with PMG)			Optional	Optional	Optional	Optional		
MX321(with PMG)							Standard	Standard

With the self-excited system, the main stator provides power via the automatic voltage regulator(AVR) to the exciter stator. The high efficiency AVR ensures the voltage maintaining at the rated level.

The exciter rotor output is fed to the main rotor through a three phase full wave bridge rectifier. The rectifier is protected by surge suppressor from voltage spikes of short circuit or phase mismatching.

## Application

Prime power, rental, telecom, mobile power station, lighting tower, railway, refrigeration and standby power.

## Quality assurance

XN series alternators are manufactured using production procedures having a quality assurance level to ISO 9001.

*Note: Continuous development of our products entitles us to change specification details without notice, therefore they must not be regarded as binding.*

## XN4FG Parameters (WINDING 311)

CONTROL SYSTEM	SELF EXCITED		
A.V.R.	SX440	SX421	
VOLTAGE REGULATION	± 1.0 %	± 0.5 %	With 4% ENGINE GOVERNING
SUSTAINED SHORT CIRCUIT	WILL NOT SUSTAIN A SHORT CIRCUIT		

INSULATION SYSTEM	H							
RATED POWER FACTOR	0.8							
PROTECTION	IP23							
STATOR WINDING	DOUBLE LAYER CONCENTRIC							
PITCH	2/3							
WINDING LEADS	12							
STATOR WDG. RESISTANCE	0.0073 Ohms PER PHASE AT 22°C SERIES STAR CONNECTED							
ROTOR WDG. RESISTANCE	1.37 Ohms at 22°C							
R.F.I. SUPPRESSION	BS EN 61000-6-2 & BS EN 61000-6-4, VDE 0875G, VDE 0875N. refer to factory for others							
WAVEFORM DISTORTION	NO LOAD < 1.5% NON-DISTORTING BALANCED LINEAR LOAD < 5.0%							
MAXIMUM OVERSPEED	2250 Rev/Min							
BEARING DRIVE END	BALL. 6317 (ISO)							
BEARING NON-DRIVE END	BALL. 6314 (ISO)							
	1 BEARING				2 BEARING			
WEIGHT COMP. GENERATOR	1160 kg				1160 kg			
WEIGHT WOUND STATOR	535kg				535kg			
WEIGHT WOUND ROTOR	463kg				463kg			
WR <sup>2</sup> INERTIA	5.4292 kgm <sup>2</sup>				5.2304 kgm <sup>2</sup>			
SHIPPING WEIGHTS in a crate	1775 kg				1780 kg			
PACKING CRATE SIZE	155 x 87 x 107(cm)				156 x 87 x 107(cm)			
	50HZ				60HZ			
TELEPHONE INTERFERENCE	THF<2%				TIF<50			
COOLING AIR	0.486 m <sup>3</sup> /sec 1030 cfm				0.580 m <sup>3</sup> /sec 1240 cfm			
VOLTAGE SERIES STAR	380/220	400/231	415/240	440/254	416/240	440/254	460/266	480/277
VOLTAGE PARALLEL STAR	190/110	200/115	208/120	220/127	208/120	220/127	230/133	240/138
VOLTAGE SERIES DELTA	220/110	230/115	240/120	254/127	240/120	254/127	266/133	277/138
kVA BASE RATING FOR REACTANCE VALUES	400	400	400	400	444	456	463	475
X <sub>d</sub> DIR. AXIS SYNCHRONOUS	2.59	2.34	2.17	1.93	3.21	2.95	2.74	2.58
X' <sub>d</sub> DIR. AXIS TRANSIENT	0.17	0.15	0.14	0.12	0.12	0.17	0.15	0.14
X'' <sub>d</sub> DIR. AXIS SUBTRANSIENT	0.12	0.11	0.1	0.09	0.09	0.12	0.11	0.1
X <sub>q</sub> QUAD. AXIS REACTANCE	2.23	2.01	1.87	1.66	1.66	2.61	2.42	2.28
X'' <sub>q</sub> QUAD. AXIS SUBTRANSIENT	0.3	0.27	0.25	0.22	0.22	0.39	0.36	0.34
X <sub>L</sub> LEAKAGE REACTANCE	0.06	0.05	0.05	0.04	0.04	0.06	0.06	0.06
X <sub>2</sub> NEGATIVE SEQUENCE	0.21	0.19	0.18	0.16	0.16	0.26	0.26	0.22
X <sub>0</sub> ZERO SEQUENCE	0.08	0.08	0.07	0.06	0.06	0.09	0.09	0.08
REACTANCES ARE SATURATED	VALUES ARE PER UNIT AT RATING AND VOLTAGE INDICATED							
T' <sub>d</sub> TRANSIENT TIME CONST.	0.08s							
T'' <sub>d</sub> SUB-TRANSTIME CONST.	0.019 s							
T' <sub>do</sub> O.C. FIELD TIME CONST.	1.7s							
T <sub>a</sub> ARMATURE TIME CONST.	0.018s							
SHORT CIRCUIT RATIO	1/X <sub>d</sub>							

EXTATION SYSTEM	SX460	SX440	AS440	MX341	MX321
VOLTAGE REGULATION RATE	±1.5%	±1.0%	±1.0%	±1.0%	±0.5%
LOW SPEED VOLTAGE DROP PROTECTION	Standard	Standard	Standard	Standard	Standard
SHORT-CIRCUITED ELECTRIC ABILITY				300%:10S	300%:10S
PARALLEL OPERATION		Optional	Optional	Optional	Optional

**XN4FG**  
**Three Phase Efficiency Curves (WINDING 311) 50HZ**

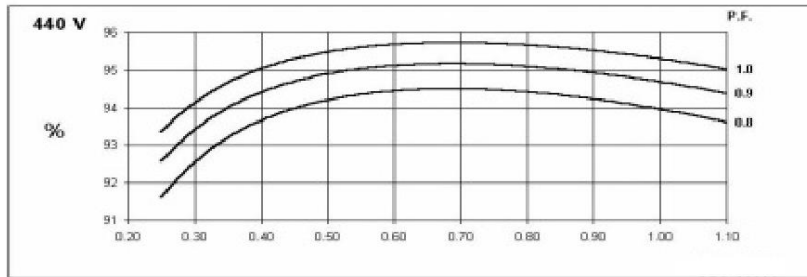
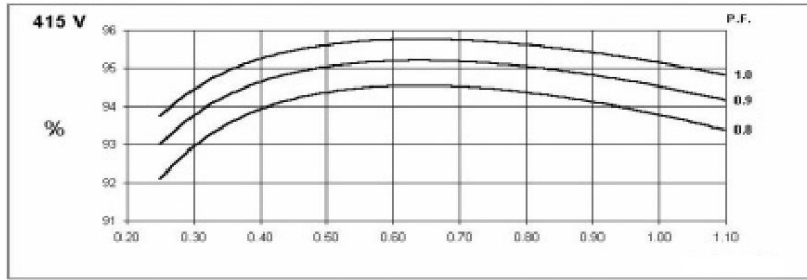
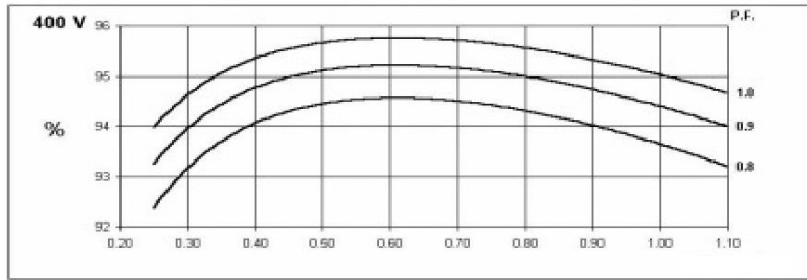
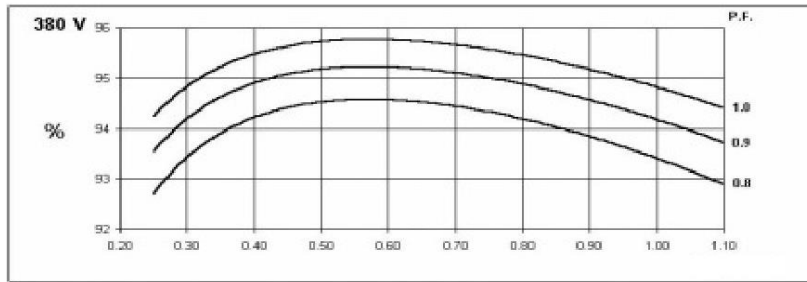

**XN4FG**  
**Three Phase Efficiency Curves (WINDING 311) 60HZ**

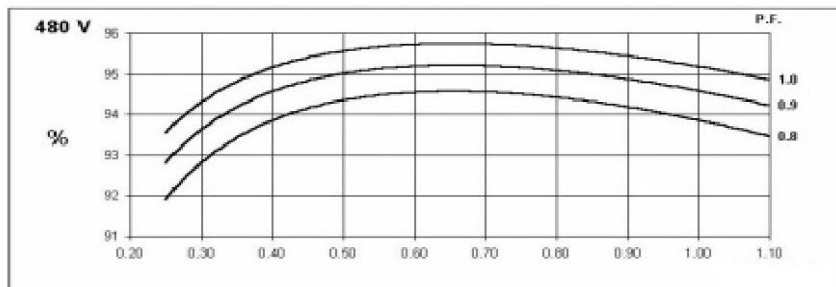
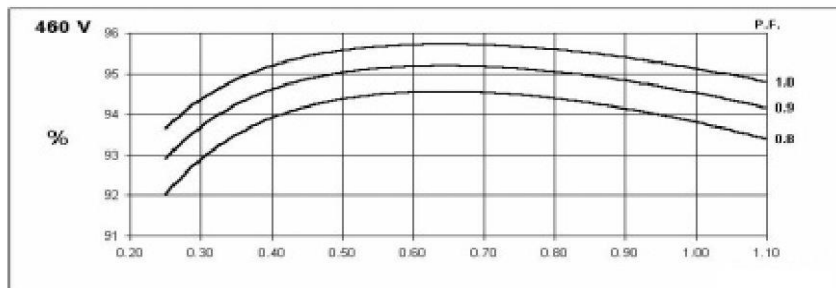
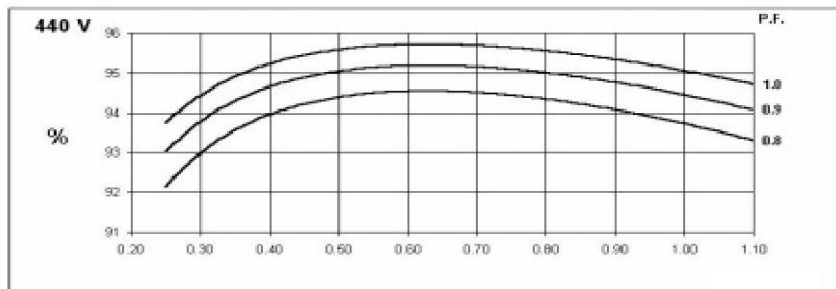
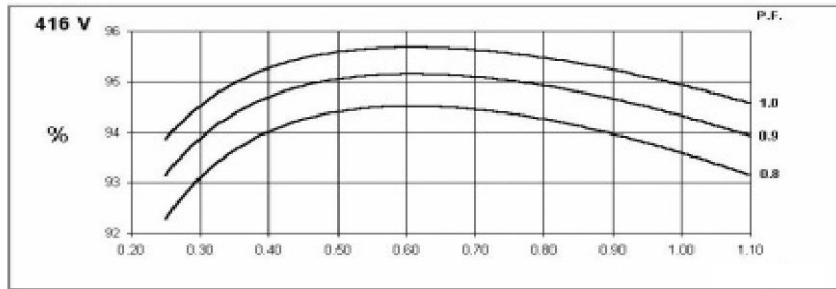

# XN4FG

## Locked Rotor Motor Starting Curve (Winding 311)

50 Hz

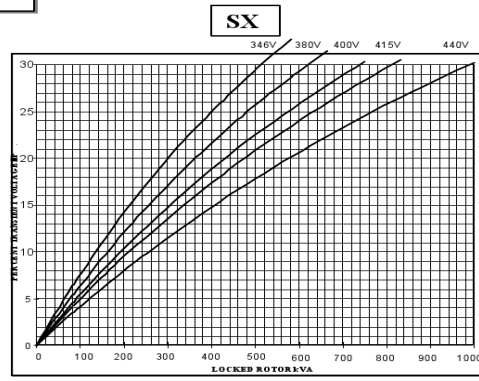
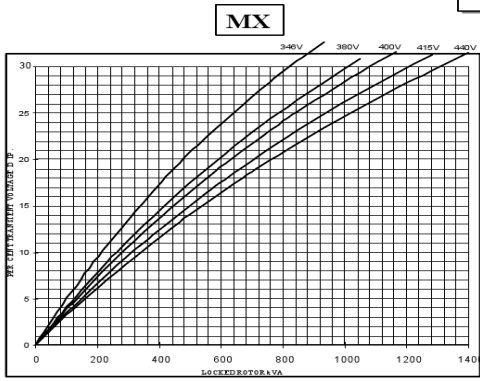

60 Hz

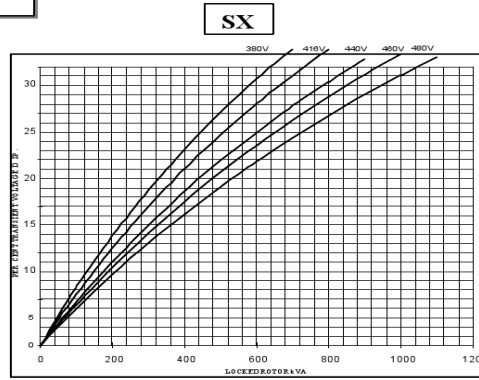
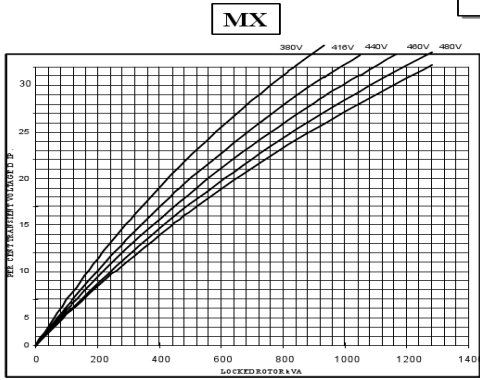

## XN4FG

### Three-phase Short Circuit Decrement Curve. No-load Excitation at Rated Speed Based on star (wye) connection.

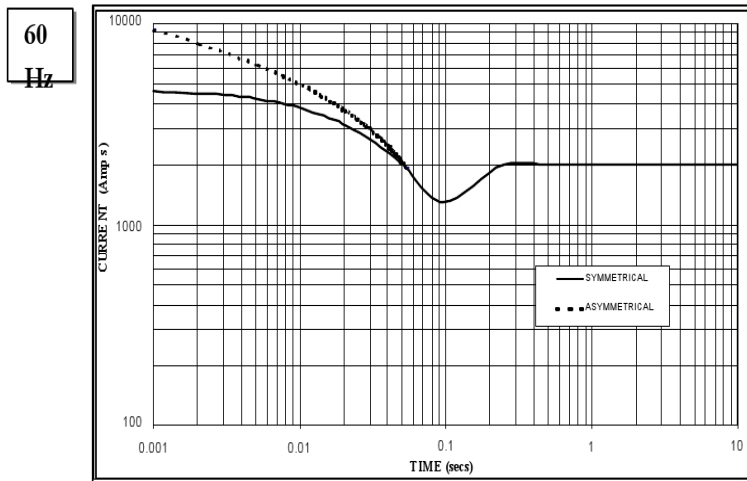
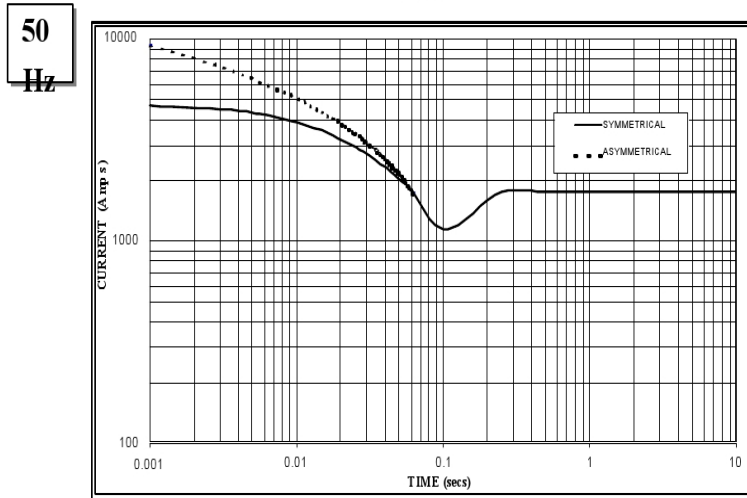

1. The following multiplication factors should be used to adjust the values from curve between time 0.001 seconds and the minimum current point in respect of nominal operating voltage

50HZ		60HZ	
Voltage	Factor	Voltage	Factor
380V	X 1.00	416V	X 1.00
400V	X 1.05	440V	X 1.06
415V	X 1.09	460V	X 1.10
440V	X 1.16	480V	X 1.15

The sustained current value is constant irrespective of voltage level

2. The following multiplication factor should be used to convert the values calculated in accordance with NOTE 1 to those applicable to the various types of short circuit :

	3-phase	2-phase L-L	1-phase L-N
Instantaneous	x 1.00	x 0.87	x 1.30
Minimum	x 1.00	x 1.80	x 3.20
Sustained	x 1.00	x 1.50	x 2.50
Max. sustained duration	10 sec.	5 sec.	2 sec.

All other times are unchanged

3. Curves are drawn for Star (Wye) connected machines.

For other connection the following multipliers should be applied to current values as shown :

Parallel Star = Curve current value X 2

Series Delta = Curve current value X 1.732

# XN4FG

## Winding 311 / 0.8 Power Factor

### RATINGS

Class - Temp Rise		Cont. F - 105/40°C				Cont. H - 125/40°C				Standby - 150/40°C				Standby - 163/27°C			
<b>50HZ</b>	Series Star (V)	380	400	415	440	380	400	415	440	380	400	415	440	380	400	415	440
	Parallel S tar (V)	190	200	208	220	190	200	208	220	190	200	208	220	190	200	208	220
	Series Delta (V) □	220	230	240	254	220	230	240	254	220	230	240	254	220	230	240	254
	kVA	350	350	350	350	400	400	400	400	390	390	390	390	450	450	450	450
	kW	280	280	280	280	320	320	320	320	312	312	312	312	360	360	360	360
	Efficiency (%)	93.8	94	94.1	94.2	93.1	93.3	93.5	94	93.3	93.5	93.7	93.9	93.1	93.4	93.5	93.7

Class - Temp Rise		Cont. F - 105/40°C				Cont. H - 125/40°C				Standby - 150/40°C				Standby - 163/27°C			
<b>60HZ</b>	Series Star (V)	416	440	460	480	416	440	460	480	416	440	460	480	416	440	460	480
	Parallel S tar (V)	208	220	230	240	208	220	230	240	208	220	230	240	208	220	230	240
	Series Delta (V) □	240	254	266	277	240	254	266	277	240	254	266	277	240	254	266	277
	kVA	405	420	425	438	425	425	440	475	475	483	488	500	488	500	506	519
	kW	324	336	340	350	340	340	352	380	380	386	390	400	390	400	405	415
	Efficiency (%)	93.9	94	94.1	94.1	93.5	93.5	93.5	93.9	93.2	93.4	93.6	93.7	93	93.2	93.4	93.5

### DIMENSIONS

